

RA 431 E
Suction nozzle curved

As at: 09/30/11 Time:16:19

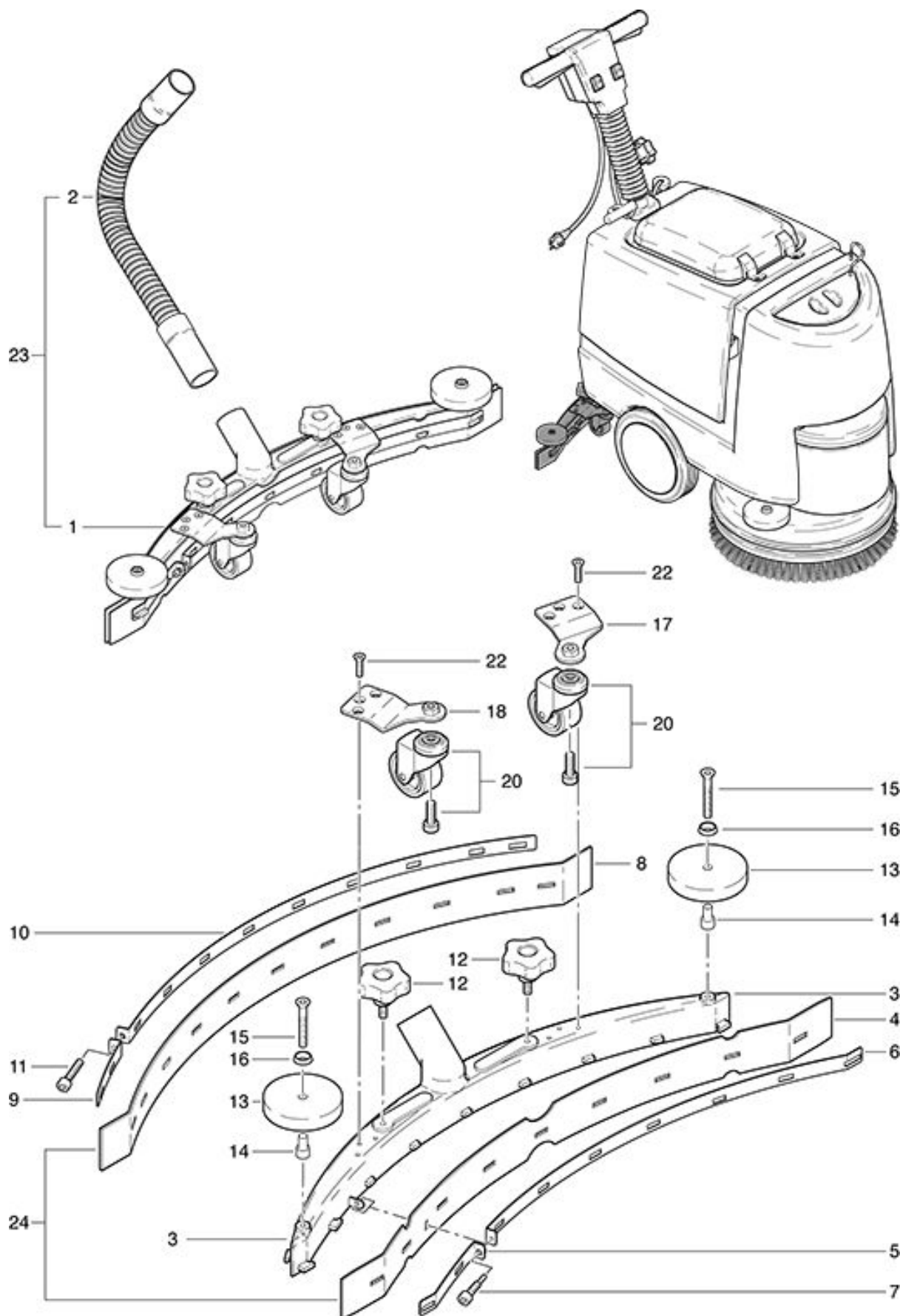

RA 431 E

Suction nozzle curved

As at: 09/30/11 Time:16:19

Pos.	Description	Reference
01	Suction nozzle curved compl. including items 3-22	432.550
02	Suction hose compl.	432.832
03	Suction nozzle body	432.555
04	Suction lip in front	432.602
05	Support plate small, in front	432.561
06	Support plate in front	432.563
07	Adjusting screw	800.425
08	Suction lip rear	432.603
09	Support plate small in the back	432.564
10	Support plate in the back	432.562
11	Cylindrical screw M 6x25	P...488 Q
12	Star handle Ø 62 M 8x18 mm	P...253 M
13	Fender wheel Ø 90 mm	510.127
14	Distance ring	432.508
15	Countersunk screw M 8x45	P...479 P
16	Disk for countersunk screw	P...500 T
17	Role owner left	432.553
18	Role owner on the right	432.554
20	Castor compl.	P...209 B
22	Countersunk screw M 6x16	P...487 W
23	Suction nozzle curved compl.	432.030
24	Rubber blade, standard	432.552
24	Rubber blade oil resistant	432.551